

***Strata***<sup>®</sup> ***CTX***

Digital Business Telephone Systems

**DKT2204-CT/DKT2304-CT  
Cordless Digital Telephones  
User Guide**

---

## Publication Information

Toshiba America Information Systems, Inc., Telecommunication Systems Division, reserves the right, without prior notice, to revise this information publication for any reason, including, but not limited to, utilization of new advances in the state of technical arts or to simply change the design of this document.

Further, Toshiba America Information Systems, Inc., Telecommunication Systems Division, also reserves the right, without prior notice, to make such changes in equipment design or components as engineering or manufacturing methods may warrant.

CTX-UG-CRDLS-VA  
4016233

Version A, June 2003

---

## © Copyright 2003 Toshiba America Information Systems, Inc. Telecommunication Systems Division

All rights reserved. No part of this manual, covered by the copyrights hereon, may be reproduced in any form or by any means—graphic, electronic, or mechanical, including recording, taping, photocopying, or information retrieval systems—without express written permission of the publisher of this material.

Strata is a registered trademark of Toshiba Corporation. Strategy is a registered trademark of Toshiba America Information Systems, Inc.

Trademarks, registered trademarks, and service marks are the property of their respective owners.

# TOSHIBA AMERICA INFORMATION SYSTEMS, INC. ("TAIS")

## Telecommunication Systems Division License Agreement

IMPORTANT: THIS LICENSE AGREEMENT ("AGREEMENT") IS A LEGAL AGREEMENT BETWEEN YOU ("YOU") AND TAIS. CAREFULLY READ THIS LICENSE AGREEMENT. USE OF ANY SOFTWARE OR ANY RELATED INFORMATION (COLLECTIVELY, "SOFTWARE") INSTALLED ON OR SHIPPED WITH A TAIS TELECOMMUNICATION SYSTEM PRODUCT OR OTHERWISE MADE AVAILABLE TO YOU BY TAIS IN WHATEVER FORM OR MEDIA, WILL CONSTITUTE YOUR ACCEPTANCE OF THESE TERMS, UNLESS SEPARATE TERMS ARE PROVIDED BY THE SOFTWARE SUPPLIER. IF YOU DO NOT AGREE WITH THE TERMS OF THIS LICENSE AGREEMENT, DO NOT INSTALL, COPY OR USE THE SOFTWARE AND PROMPTLY RETURN IT TO THE LOCATION FROM WHICH YOU OBTAINED IT IN ACCORDANCE WITH APPLICABLE RETURN POLICIES. EXCEPT AS OTHERWISE AUTHORIZED IN WRITING BY TAIS, THIS SOFTWARE IS LICENSED FOR DISTRIBUTION ONLY TO END-USERS PURSUANT TO THIS LICENSE AGREEMENT.

- License Grant.** The Software is not sold; it is licensed upon payment of applicable charges. TAIS grants to you a personal, non-transferable and non-exclusive right to use the copy of the Software provided under this License Agreement. You agree you will not copy the Software except as necessary to use it on one TAIS system at a time at one location. Modifying, translating, renting, copying, distributing, transferring or assigning all or part of the Software, or any rights granted hereunder, to any other persons and removing any proprietary notices, labels or marks from the Software is strictly prohibited; You agree violation of such restrictions will cause irreparable harm to TAIS and provide grounds for injunctive relief, without notice, against You or any other person in possession of the Software. You and any other person whose possession of the software violates this License Agreement shall promptly surrender possession of the Software to TAIS, upon demand. Furthermore, you hereby agree not to create derivative works based on the Software. TAIS reserves the right to terminate this license and to immediately repossess the software in the event that You or any other person violates this License Agreement.
- Intellectual Property.** You acknowledge that no title to the intellectual property in the Software is transferred to you. You further acknowledge that title and full ownership rights to the Software will remain the exclusive property of TAIS and/or its suppliers, and you will not acquire any rights to the Software, except the license expressly set forth above. You will not remove or change any proprietary notices contained in or on the Software. The Software is protected under US patent, copyright, trade secret, and/or other proprietary laws, as well as international treaties. Any transfer, use, or copying of the software in violation of the License Agreement constitutes copyright infringement. You are hereby on notice that any transfer, use, or copying of the Software in violation of this License Agreement constitutes a willful infringement of copyright.
- No Reverse Engineering.** You agree that you will not attempt, and if you employ employees or engage contractors, you will use your best efforts to prevent your employees and contractors from attempting to reverse compile, reverse engineer, modify, translate or disassemble the Software in whole or in part. Any failure to comply with the above or any other terms and conditions contained herein will result in the automatic termination of this license and the reversion of the rights granted hereunder back to TAIS.
- Limited Warranty.** THE SOFTWARE IS PROVIDED "AS IS" WITHOUT WARRANTY OF ANY KIND. TO THE MAXIMUM EXTENT PERMITTED BY APPLICABLE LAW, TAIS AND ITS SUPPLIERS DISCLAIM ALL WARRANTIES WITH REGARD TO THE SOFTWARE, EITHER EXPRESS OR IMPLIED, INCLUDING, BUT NOT LIMITED TO, THE WARRANTY OF NON-INFRINGEMENT OF THIRD PARTY RIGHTS, THE WARRANTY OF YEAR 2000 COMPLIANCE, AND THE IMPLIED WARRANTIES OF MERCHANTABILITY AND FITNESS FOR A PARTICULAR PURPOSE. THE ENTIRE RISK AS TO THE QUALITY AND PERFORMANCE OF THE SOFTWARE IS WITH YOU. NEITHER TAIS NOR ITS SUPPLIERS WARRANT THAT THE FUNCTIONS CONTAINED IN THE SOFTWARE WILL MEET YOUR REQUIREMENTS OR THAT THE OPERATION OF THE SOFTWARE WILL BE UNINTERRUPTED OR ERROR-FREE. HOWEVER, TAIS WARRANTS THAT ANY MEDIA ON WHICH THE SOFTWARE IS FURNISHED IS FREE FROM DEFECTS IN MATERIAL AND WORKMANSHIP UNDER NORMAL USE FOR A PERIOD OF NINETY (90) DAYS FROM THE DATE OF DELIVERY TO YOU.
- Limitation of Liability.** TAIS' ENTIRE LIABILITY AND YOUR SOLE AND EXCLUSIVE REMEDY UNDER THIS LICENSE AGREEMENT SHALL BE AT TAIS' OPTION REPLACEMENT OF THE MEDIA OR REFUND OF THE PRICE PAID. TO THE MAXIMUM EXTENT PERMITTED BY APPLICABLE LAW, IN NO EVENT SHALL TAIS OR ITS SUPPLIERS BE LIABLE TO YOU FOR ANY CONSEQUENTIAL, SPECIAL, INCIDENTAL OR INDIRECT DAMAGES FOR PERSONAL INJURY, LOSS OF BUSINESS PROFITS, BUSINESS INTERRUPTION, LOSS OF BUSINESS INFORMATION/DATA, OR ANY OTHER PECUNIARY LOSS OF ANY KIND ARISING OUT OF THE USE OR INABILITY TO USE THE SOFTWARE, EVEN IF TAIS OR ITS SUPPLIER HAS BEEN ADVISED OF THE POSSIBILITY OF SUCH DAMAGES. IN NO EVENT SHALL TAIS OR ITS SUPPLIERS BE LIABLE FOR ANY CLAIM BY A THIRD PARTY.
- State/Jurisdiction Laws.** SOME STATES/JURISDICTIONS DO NOT ALLOW THE EXCLUSION OF IMPLIED WARRANTIES OR LIMITATIONS ON HOW LONG AN IMPLIED WARRANTY MAY LAST, OR THE EXCLUSION OR LIMITATION OF INCIDENTAL OR CONSEQUENTIAL DAMAGES, SO SUCH LIMITATIONS OR EXCLUSIONS MAY NOT APPLY TO YOU. THIS LIMITED WARRANTY GIVES YOU SPECIFIC RIGHTS AND YOU MAY ALSO HAVE OTHER RIGHTS WHICH VARY FROM STATE/JURISDICTION TO STATE/JURISDICTION.
- Export Laws.** This License Agreement involves products and/or technical data that may be controlled under the United States Export Administration Regulations and may be subject to the approval of the United States Department of Commerce prior to export. Any export, directly or indirectly, in contravention of the United States Export Administration Regulations, or any other applicable law, regulation or order, is prohibited.
- Governing Law.** This License Agreement will be governed by the laws of the State of California, United States of America, excluding its conflict of law provisions.
- United States Government Restricted Rights.** The Software is provided with Restricted Rights. Use, duplication, or disclosure by the United States Government, its agencies and/or instrumentalities is subject to restrictions as set forth in subparagraph (c)(1)(ii) of The Rights in Technical Data and Computer Software Clause at DFARS 252.227-7013 (October 1988) or subparagraphs (c)(1) and (2) of the Commercial Computer Software - Restricted Rights at 48 CFR 52.227-19, as applicable.
- Severability.** If any provision of this License Agreement shall be held to be invalid, illegal or unenforceable, the validity, legality and enforceability of the remaining provisions hereof shall not in any way be affected or impaired.
- No Waiver.** No waiver of any breach of any provision of this License Agreement shall constitute a waiver of any prior, concurrent or subsequent breach of the same or any other provisions hereof, and no waiver shall be effective unless made in writing and signed by an authorized representative of the waiving party.

YOU ACKNOWLEDGE THAT YOU HAVE READ THIS LICENSE AGREEMENT AND THAT YOU UNDERSTAND ITS PROVISIONS. YOU AGREE TO BE BOUND BY ITS TERMS AND CONDITIONS. YOU FURTHER AGREE THAT THIS LICENSE AGREEMENT CONTAINS THE COMPLETE AND EXCLUSIVE AGREEMENT BETWEEN YOU AND TAIS AND SUPERSEDES ANY PROPOSAL OR PRIOR AGREEMENT, ORAL OR WRITTEN, OR ANY OTHER COMMUNICATION RELATING TO THE SUBJECT MATTER OF THIS LICENSE AGREEMENT.

**Toshiba America Information Systems, Inc.**  
**Telecommunication Systems Division**

9740 Irvine Boulevard  
Irvine, California 92618-1697  
United States of America

TSDD 081601

5932

# **Toshiba America Information Systems, Inc.**

## **Telecommunication Systems Division**

### **Limited Warranty**

Toshiba America Information Systems, Inc., (“TAIS”) warrants that this voice processing equipment (except for fuses, lamps, and other consumables) will, upon delivery by TAIS or an authorized TAIS dealer to a retail customer in new condition, be free from defects in material and workmanship for twenty-four (24) months after delivery. This warranty is void (a) if the equipment is used under other than normal use and maintenance conditions, (b) if the equipment is modified or altered, unless the modification or alteration is expressly authorized by TAIS, (c) if the equipment is subject to abuse, neglect, lightning, electrical fault, or accident, (d) if the equipment is repaired by someone other than TAIS or an authorized TAIS dealer, (e) if the equipment’s serial number is defaced or missing, or (f) if the equipment is installed or used in combination or in assembly with products not supplied by TAIS and which are not compatible or are of inferior quality, design, or performance.

The sole obligation of TAIS or Toshiba Corporation under this warranty, or under any other legal obligation with respect to the equipment, is the repair or replacement by TAIS or its authorized dealer of such defective or missing parts as are causing the malfunction with new or refurbished parts (at their option). If TAIS or one of its authorized dealers does not replace or repair such parts, the retail customer’s sole remedy will be a refund of the price charged by TAIS to its dealers for such parts as are proven to be defective, and which are returned to TAIS through one of its authorized dealers within the warranty period and no later than thirty (30) days after such malfunction, whichever first occurs.

Under no circumstances will the retail customer or any user or dealer or other person be entitled to any direct, special, indirect, consequential, or exemplary damages, for breach of contract, tort, or otherwise. Under no circumstances will any such person be entitled to any sum greater than the purchase price paid for the item of equipment that is malfunctioning.

To obtain service under this warranty, the retail customer must bring the malfunction of the machine to the attention of one of TAIS’ authorized dealers within the twenty-four (24) month period and no later than thirty (30) days after such malfunction, whichever first occurs. Failure to bring the malfunction to the attention of an authorized TAIS dealer within the prescribed time results in the customer being not entitled to warranty service.

**THERE ARE NO OTHER WARRANTIES FROM EITHER TOSHIBA AMERICA INFORMATION SYSTEMS, INC., OR TOSHIBA CORPORATION WHICH EXTEND BEYOND THE FACE OF THIS WARRANTY. ALL OTHER WARRANTIES, EXPRESS OR IMPLIED, INCLUDING THE WARRANTIES OF MERCHANTABILITY, FITNESS FOR A PARTICULAR PURPOSE, AND FITNESS FOR USE, ARE EXCLUDED.**

No TAIS dealer and no person other than an officer of TAIS may extend or modify this warranty. No such modification or extension is effective unless it is in writing and signed by the vice president and general manager, Telecommunication Systems Division.

# Contents

---

## Introduction

Organization.....	v
Conventions .....	vi
Related Documents and Media .....	vi

## Chapter 1 – The Grand Tour

Technology .....	2
Applications .....	3
Benefits .....	3
Handset .....	4
DKT2204-CT.....	5
DKT2304-CT .....	7
LCD Display .....	9
Base Unit.....	9
Charging Unit.....	10
DKT2204-CT.....	10
DKT2304-CT.....	10
Cordless Digital Telephone Standard Parts .....	11

## Chapter 2 – Installation

Step 1: Review Safety Instructions .....	13
Step 2: Select Location .....	16
Step 3: Place DKT3000-series Telephones into 2000-Mode.....	16
Step 4: Connect Telephone Cables .....	17
Step 5: Connect and Apply Power .....	18

## Contents

### Chapter 3 – Handset Operation

Base Unit .....	18
Charging Unit .....	18
Step 6: (Optional) Wall Installation .....	19
Standard Wall Plate Mounting.....	19
Direct Wall Mounting.....	20
Charging Unit Wall Mounting.....	21
Step 7: Raise the Base Unit Antenna .....	23
Step 8: Install Handset Battery Pack.....	23
DKT2204-CT.....	23
DKT2304-CT.....	23
Step 9: Charge Batteries for First Time .....	24
Step 10: Install Headset (Optional).....	24
Step 11: Attach Belt Clip (Optional) .....	25

## Chapter 3 – Handset Operation

Handset Controls.....	27
Earpiece Volume .....	27
Handset Ringer Tone and Volume .....	28
Mute (DKT2204-CT only) .....	28
Handset Ringer Mute (DKT2304-CT only) .....	28
Vibrate Mode.....	28
Ringer Off Slide Switch (DKT2204-CT only) .....	29
F1~F4 Feature Buttons.....	29
Making a Call.....	30
Internal Call .....	30
External Call .....	30
Answer a Call.....	31
Internal Call .....	31
External Call .....	31
Place a Call on Hold .....	32
Transfer a Call.....	32
Redial a Number .....	32
Retrieve Messages .....	32
Conference a Call.....	32
Conference Calls Using Strata CTX.....	33

- Adding Voice Mail to a Conference .....34
- Connecting Two Outside Lines .....34
- Switch a Call to Your Cordless Digital Telephone.....35
- Switch a Call to the Desk Telephone .....35
  
- Chapter 4 – Feature Access Codes .....37**
  
- Chapter 5 – Troubleshooting and Specifications**
- Troubleshooting .....45
  - Low Battery .....47
  - Cleaning Charging Unit Contacts .....48
  - Charging Spare Battery Packs (DKT2204-CT only).....48
- Simultaneous Conversation Channels.....49
  - DKT2204-CT.....49
  - DKT2304-CT.....49
- Range and Performance .....50
- Radio Interference.....50
- Telephone Line Problems .....50
- Privacy .....51
- Specifications .....52
  
- Index .....53**

## **Contents**

*Chapter 5 – Troubleshooting and Specifications*



# Introduction

---

This guide describes the features and operation of the Strata CTX DKT2204-CT and DKT2304-CT Cordless Digital Telephones with Strata CTX Business Telephone Systems. To get the most from your cordless telephone, please read this guide thoroughly.

The DKT2204-CT and DKT2304-CT also work with Strata DK telephone systems (except Strata DK24/56/96, Release 3). Refer to the appropriate user guide for your telephone system (see [“Related Documents and Media”](#) on page viii).

The information presented in this guide applies to both models of cordless telephones unless otherwise noted.

## Organization

This user guide is divided as follows:

- **Chapter 1 – The Grand Tour** is an equipment overview of the handset and batteries, base and charging units.
- **Chapter 2 – Installation** has step-by-step installation instructions.
- **Chapter 3 – Handset Operation** covers operating controls and features.
- **Chapter 4 - Feature Access Codes** includes codes used for specific feature access.
- **Chapter 5 - Troubleshooting and Specifications** covers troubleshooting, range and performance, simultaneous conversation channels, radio interference, specifications, and access codes.

# Conventions

Conventions	Description
<b>Note</b>	Elaborates specific items or references other information. Within some tables, general notes apply to the entire table and numbered notes apply to specific items.
<b>Important!</b>	<i>Calls attention to important instructions or information.</i>
<b>WARNING!</b>	<b>Alerts you when the given task could cause personal injury or death.</b>
<b>Arial Bold</b>	Represents telephone buttons.
<b>Courier</b>	Shows a computer keyboard entry or screen display.
Tilde (~)	Means “through.” Example: 350 ~ 640 Hz frequency range.
➤	Denotes the step in a one-step procedure.
➤	Denotes a procedure.
See Figure 10	Grey words within the printed text denote cross-references. In the electronic version of this document. Library CD-ROM or FYI Internet download), cross-references appear in blue hypertext.

## Related Documents and Media

**Note** Some documents listed here may appear in different versions on the CD-ROM or in print. To find the most current version, check the version/date in the Publication Information on the back of the document’s title page.

The following documents/media can be used to reference further information about the Strata CTX systems.

- Strata CTX WinAdmin Application Software and CTX/DK/Partner Products Documentation Library
- Strata CTX DKT/IPT Telephone User Guide

This chapter familiarizes you with the Strata CTX DKT2204-CT and DKT2304-CT Cordless Digital Telephones (e.g., handset, batteries, base and charging units, fixed buttons). [Chapter 4 – Feature Access Codes](#), beginning on [page 37](#) covers the four pre-assigned flexible buttons.

Your cordless digital telephone is engineered to work with your Toshiba digital telephone system and provide you with reliability, long life, and outstanding performance.

The cordless digital telephone is compatible with all Strata CTX and Strata DK telephone systems (except Strata DK24/56/96, Release 3). All it requires for connection is a digital station port.

Fully charged, your cordless digital telephone provides:

- DKT2204-CT: six hours of talk time and four days of standby time.
- DKT2304-CT: seven hours of talk time and five days of standby time.

There is a fast charger in the handset and a trickle charger in the base.

You can use your cordless as a stand-alone phone attached to a digital port, or in conjunction with a DKT3000/2000-series digital telephone—in which case both phones share the same digital port and extension number. You can switch between use of your DKT and your cordless, just by pressing a button.

**Note** If using a DKT3000 digital telephone, it must be set to operate in DKT2000 mode.

Some of its features are:

- Liquid Crystal Display (LCD) that wraps using two lines, total of 32 characters
- Ringer and handset volume control
- Single button access to: Conference, Hold, Redial, Message and Transfer features
- Four programmable function buttons
- Charging stand (with spare battery charging capability on DKT2204-CT)
- AutoStandby
- AutoTalk
- Vibrate ringer alert
- Out-of-range protection
- Low-battery protection system
- Wall-mountable separate base and charging unit
- Headset jack (2.5mm)
- Stand-alone or DKT operation
- High quality ultra-secure conversation with 32Kbps Adaptive Differential Pulse Code Modulation (ADPCM) voice code combination.
- Three ring tones

## Technology

Your DKT2204-CT uses digital 900 MHz spread-spectrum technology, which represents state-of-the-art design and engineering. The DKT2304-CT uses 900 MHz Digital Narrow Band technology. These technologies provide:

- Unsurpassed range, several times greater than conventional analog or cordless digital telephones.
- Clarity that is so good, it is indistinguishable from corded telephones in most environments.
- (DKT2204-CT) Fully secure communications for up to 10 cordless digital telephones within a given environment.
- (DKT2304-CT) Maximum security for up to 30 cordless digital telephones that is almost impossible to scan.

# Applications

Your cordless digital telephone brings mobility and productivity to office telephones. Greater call access cuts down on “telephone tag” delays. Its compact design makes it easy to take with you.

## Benefits

Your cordless digital telephone uses advanced technology and provides important features that place it far above the competition in functionality and value. You benefit from much greater performance than other cordless telephones currently available. This means better sound quality, longer range, greater security, multi-line access, helpful LCD display information, and many other important advantages.

The cordless digital telephone provides many advantages over a single-line analog or digital telephone. Some of those advantages are:

- Your cordless digital telephone has four flexible feature buttons. They have the same functions as the first four buttons on the 3000/2000-series desk DKT. If you do not use these buttons for the assigned features, you can invoke other features with access codes.
- Your cordless digital telephone rings to the same extension number as the regular DKT it is used with, enabling you to answer via either telephone. Both follow the same forwarding and hunting regardless of which telephone is in use. This is much simpler than having a separate extension number and standard station port for a single-line cordless.
- An SLT cordless is not only a cumbersome alternative to the Toshiba digital cordless; but also, if you forget to forward your calls, you cannot receive the calls on your SLT cordless. With your cordless digital telephone it is easy. Just press a button, grab your cordless, and go!
- A Message Waiting icon  appears on the LCD when message(s) are in the user’s mailbox.

In addition to the benefits mentioned above, the DKT2204-CT also has the following benefits:

- Spread-spectrum technology provides five to seven times greater range than conventional cordless telephones, making your cordless digital telephone much more useful and valuable.

- 900 MHz spread-spectrum operation provides maximum security with a frequency range that is almost impossible to scan. Regular 900 MHz cordless digital telephones are difficult to scan, but less so than spread spectrum. Analog cordless telephone frequencies are easy to scan and provide virtually no security from the outside. Hackers and thieves can use this to hear conversations and pick up credit card numbers.
- Sound quality is better on your cordless digital telephone than non-spread spectrum 900 MHz digital cordless telephones. Sound quality on conventional analog cordless telephones is so poor by comparison that they are only practical for short range usage.

## Handset

Your cordless handset has special function buttons (shown below) and an LCD that shows operating conditions.

**Note** The handset and base unit of your cordless telephone is equipped with the same security code. In order for this handset to operate, it must be installed with the matching base unit.

## DKT2204-CT

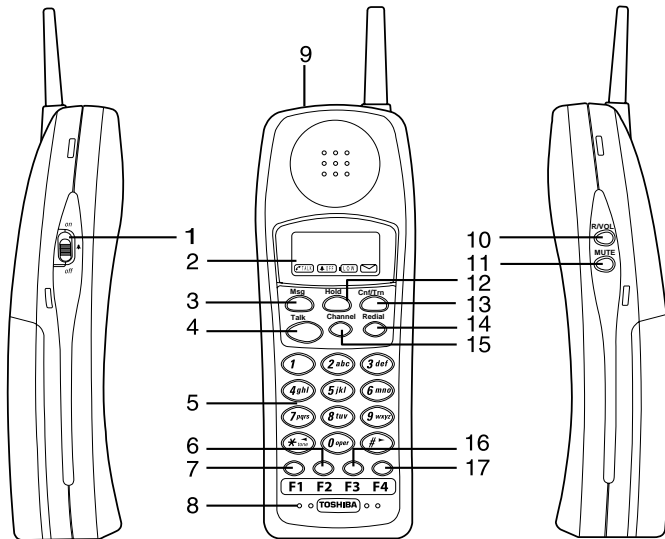

- |                                |   |
|--------------------------------|---|
| 1. Ringer Off Slide Switch     | 10. <b>R/VOL</b> (Volume) Button                |
| 2. Message Display             | 11. <b>MUTE</b> Button                          |
| 3. <b>Msg</b> (Message) Button | 12. <b>Hold</b> Button                          |
| 4. <b>Talk</b> Button          | 13. <b>Cnf/Trn</b> (Conference/Transfer) Button |
| 5. Numeric Dial Pad            | 14. <b>Redial</b> Button                        |
| 6. <b>F2</b> Button            | 15. <b>Channel</b> Button                       |
| 7. <b>F1</b> Button            | 16. <b>F3</b> Button                            |
| 8. Microphone                  | 17. <b>F4</b> Button                            |
| 9. Headset Jack                |   |

Table 1 DKT2204-CT Fixed Button Description

Button	Description
<b>Talk</b>	Initiates and disconnects calls.
<b>R/VOL</b>	Selects ringer tone and volume in standby mode and speaker volume in talk mode.
<b>Channel</b>	<p>Selects channel while in talk mode and locks the handset while in standby mode.</p> <p>Press this key if you encounter interference while using your telephone. You can manually change the telephone's channel for clear operation.</p>
<b>Redial</b>	<p>To dial the last number called, press <b>Talk</b>, then <b>Redial</b>. The last number called is redialed.</p> <p><b>Note</b> If you are using the Strata CTX system, the <b>Redial</b> button works only with the last dialed number that was answered. If you dial a number and receive no answer, the <b>Redial</b> button will not use that number as the last one dialed.</p>
<b>Hold</b>	Press once and the call is placed on hold. Press <b>Hold</b> or <b>Talk</b> to resume the call (local hold).
<b>Msg</b>	Press to retrieve voice messages.
<b>Cnf/Trn</b>	Conferences and transfers calls.
<b>MUTE</b>	Toggles the mute feature On and Off (mutes your conversation away from the handset).
<b>on/off</b>	This Ringer Off Slide Switch turns the handset ringer On or Off.



## DKT2304-CT

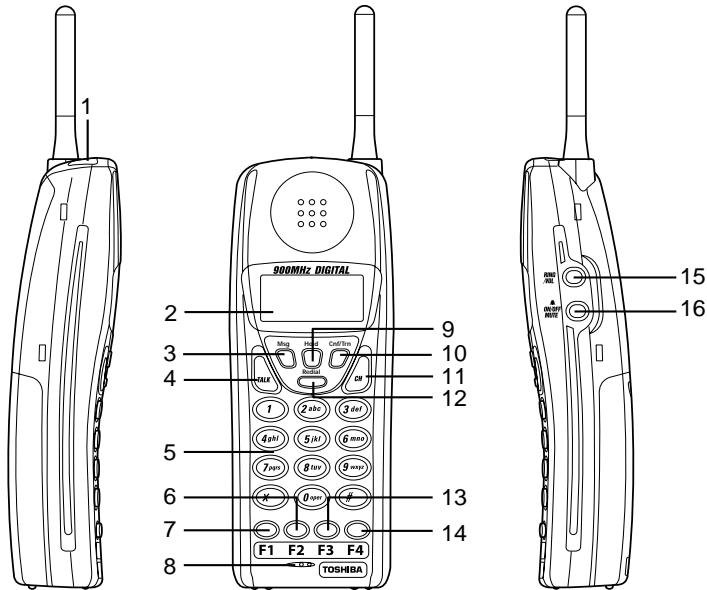

- . Headset Jack
- . Display
- . **Msg** (Message) Button
- . **TALK** Button
- . Numeric Dial Pad
- . **F2** Button
- . **F1** Button
- . Microphone
- 9. **Hold** Button
- 10. **Cnf/Trn** (Conference/Transfer) Button
- 11. **CH** (Channel) Button
- 12. **Redial** Button
- 13. **F3** Button
- 14. **F4** Button
- 15. **RING/VOL** (Volume) Button
- 16. Ringer On/Off & Mic Mute (**ON/OFF MUTE**) Button

Table 2 DKT2304-CT Fixed Button Description

Button	Description
<b>TALK</b>	Initiates and disconnects calls.
<b>RING/VOL</b>	Selects ringer tone and volume in standby mode and speaker volume in talk mode.
<b>CH</b>	Selects channel while in talk mode and locks the handset while in standby mode.  Press this key if you encounter interference while using your telephone. You can manually change the telephone's channel for clear operation.
<b>Redial</b>	To dial the last number called, press <b>Talk</b> , then <b>Redial</b> . The last number called is redialed.  <b>Note</b> If you are using the Strata CTX system, the <b>Redial</b> button works only with the last dialed number that was answered. If you dial a number and receive no answer, the <b>Redial</b> button will not use that number as the last one dialed.
<b>Hold</b>	Press once and the call is placed on hold. Press <b>Hold</b> or <b>Talk</b> to resume the call (local hold).
<b>Msg</b>	Press to retrieve voice messages.
<b>Cnf/Trn</b>	Conferences and transfers calls.
<b>ON/OFF MUTE</b>	Toggles the handset ringer tone On and Off.

## LCD Display

The LCD display consists of two lines of 16 characters each with four icons—Talk, Ringer Off, Low (Battery) and Message Waiting .

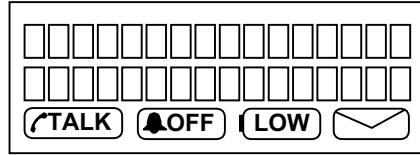

## Base Unit

The base unit can be used as a desktop or wall-mounted unit (shown below). There are two LEDs that indicate Desk or Cordless mode.

**Note** The handset and base unit of your cordless telephone is equipped with the same security code. In order for this base unit to operate, it must be installed with the matching handset.

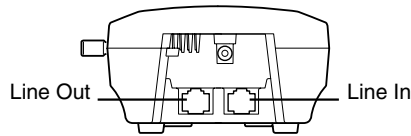
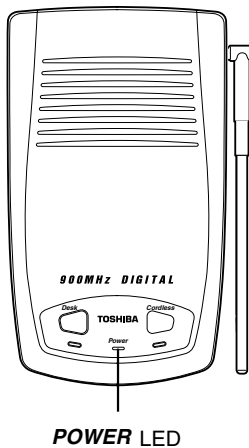

# Charging Unit

## DKT2204-CT

The handset comes with a charging unit (shown at right) that has two slots.

The front slot functions as a cradle for the handset when idle and a charger for the handset battery.

The rear slot is for spare battery charging. It automatically discharges when it detects that discharging is necessary.

**CHARGE** and **BATT CHARGE** LEDs indicate battery charging status. The LEDs flash red when charging, and are steady red when the battery is charged.

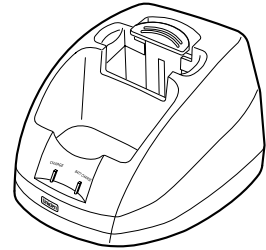

## DKT2304-CT

The handset comes with a charging unit (shown at right) that has a slot in the front.

The slot functions as a cradle for the handset when idle and a charger for the handset battery.

The **CHARGE** LED indicates battery charging status. The LED flashes red when charging, and is steady red when the battery is charged.

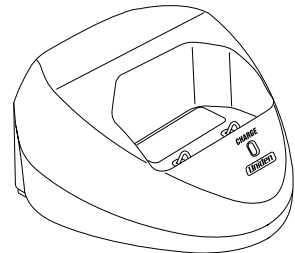

# Cordless Digital Telephone Standard Parts

Your Toshiba cordless digital telephone includes the following items:

- Base unit
- Handset
- Telephone cord (two ft.)
- Two AC adapters
- Rechargeable battery
- Belt clip
- Wall plate adapter
- Wall mount for charging unit (DKT2304-CT only)
- Charging unit
- User Guide

If any of these items are missing or damaged, contact your System Administrator.

**The Grand Tour**

*Cordless Digital Telephone Standard Parts*

## Step 1: Review Safety Instructions

**WARNING!** Toshiba DOES NOT represent this unit to be waterproof. To reduce the risk of fire, electrical shock, or damage to the unit, DO NOT expose this unit to rain or moisture.

- Read and understand all product instructions.
- Follow all warnings and instructions marked on the product.
- Cleaning precautions:
  - Unplug this product from the wall outlet before cleaning.
  - Do not use liquid cleaners or aerosol cleaners.
  - Use a dry cloth for cleaning.
- Do not use this product near water; for example, near a sink, or in any wet area.
- Never spill liquid of any kind on the product.
- Do not place this product on an unstable cart, stand, or table. The telephone could fall, causing serious damage to the unit.
- To protect the product from overheating, do not:
  - Block or cover any slots or openings in the base unit.
  - Place near or over a radiator or heat register.
  - Place in an enclosed cabinet unless proper ventilation is provided.

## Installation

### Step 1: Review Safety Instructions

- Operate this product only from the type of power source indicated on the marking label.
- Do not allow anything to rest on the power cord. Do not locate this product where the cord could be damaged by persons walking on it.
- Do not overload wall outlets and extension cords because it could result in fire or electrical shock.
- Never push objects of any kind into the base unit slots, as the objects could touch dangerous voltage points or short out parts that could cause fire or electric shock.
- To reduce the risk of electric shock, do not disassemble this product. Opening or removing covers could expose you to dangerous voltages or other risks. Incorrect re-assembly can cause electric shock when the appliance is subsequently used. Contact qualified service personnel when service or repair work is required.
- Unplug this product from the wall outlet and refer servicing to qualified service personnel under the following conditions:
  - When the power supply cord is damaged or frayed.
  - If liquid has been spilled into the product.
  - If the product has been exposed to rain or water.
  - If the product does not operate normally when following the operating instructions. Adjust only those controls that are covered by the operating instructions. Improper adjustment of other controls may result in damage, and will often require extensive work by a qualified technician to restore the product to normal operation.
  - If the product has been dropped, or the cabinet has been damaged.
  - If the product exhibits a distinct change in performance.
- Do not use the telephone to report a gas leak in the vicinity of the leak.

**WARNING! Do not attempt to unplug any appliance during an electrical storm.**

- Unplug all electrical appliances when you know an electrical storm is approaching. Lightning can pass through the wiring and damage any device connected to it. This telephone is no exception.



---

**CAUTION!** Changes or modifications to this product not expressly approved by Toshiba, or operation of this product in any way other than as detailed by this User Guide, could void your authority to operate this product.

---

- WARNING!** To reduce the risk of fire and/or personal injury from the Nickel-Cadmium battery, follow these instructions:
- Use only battery model BT-2499 (DKT2204-CT) or BT930 (DKT2304-CT). Use of any other battery could cause a safety hazard.
  - Do not dispose of the battery in a fire. The cell will explode. Under federal, state and local laws, it could be illegal to dispose of old batteries by placing them in the trash. Check with your local government for information on where to recycle or dispose of old batteries. If you cannot find the information you need, contact Toshiba for assistance.
  - Do not remove or damage the battery casing.
  - Do not short circuit the battery. Exercise care in handling the battery in order not to short the battery with rings, bracelets, and keys or other conductive materials. The battery or conductor could overheat and cause burns.
  - Charge the battery only in accordance with the instructions and limitations specified in the instruction manual provided for this product.
  - Do not charge the Rechargeable battery in any charger other than the one designed to charge it as specified in this user guide. Using another charger may damage the battery, or cause the battery to explode.
  - Observe proper polarity orientation between the battery and charging unit.

## Step 2: Select Location

1. Select a location that is not subject to excessive heat or humidity. Keep the base unit and handset away from sources of electrical noise, such as motors and fluorescent lighting.
2. Determine if the base unit will sit on your desk or be wall mounted. If wall mounted, go to [Step 6: “\(Optional\) Wall Installation”](#) on page 19.
3. Place the base unit on a desk or tabletop near a standard 120VAC outlet and within reach of the Strata CTX digital line connection.

**Important!** *Place the base unit to the right of the DKT. If placed on the left, the cordless antenna picks up a tone due to its close proximity to the DKT speaker and electronic parts.*

## Step 3: Place DKT3000-series Telephones into 2000-Mode

You must place your DKT3000-series telephone into 2000-mode before connecting the cordless telephone; otherwise, the 3000-series telephone will not work.

In 2000-mode, the DKT3000 telephone operation changes are:

- Only 16 characters by two lines display on the LCD.
- LCD Feature button does not work
- **Spdial** button does not work

### ► To change DKT3000-series telephones into 2000-mode

1. On the DKT3000 telephone, press **3+6+9+Hold** (simultaneously).
2. Press **#**.
3. Press **FB7** (or **FB10** on the DKT3014). LED On = 2000 mode. LED Off = 3000 mode.

**Note** Flexible Buttons (FB) are numbered from the bottom up and left to right.

**FB7** for example would be the seventh button up on the left.

4. Press **Hold**.
5. Lift the handset to exit programming mode. Wait a few seconds for the telephone to reset itself.

## Step 4: Connect Telephone Cables

Your cordless telephone must be connected to a digital telephone PBX port.

- WARNING!**
- Never install telephone wiring during a lightning storm.
  - Never touch uninsulated telephone wires or terminals unless the telephone line has been disconnected at the network interface.
  - Use caution when installing or modifying telephone lines.

### ➤ To connect as a stand-alone telephone

- Connect the modular jack labeled “Line In” directly to the telephone wall jack using one of the supplied cables (shown at right).

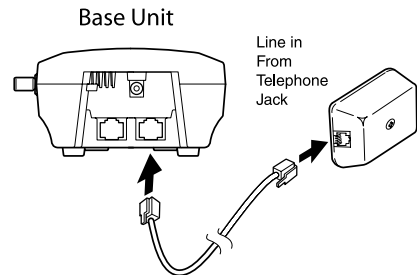

### ➤ To connect to a Strata DKT

1. Unplug the cable from the DKT and plug into the “Line In” jack of cordless telephone base unit (shown at right).
2. Plug the additional two-foot cable into the “Line Out” jack of the base unit and into the DKT jack located on the bottom of the telephone.

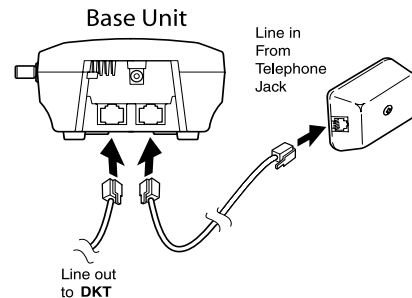

## Installation

### Step 5: Connect and Apply Power

# Step 5: Connect and Apply Power

## Base Unit

1. Plug the AC adapter cord into the AC adapter input jack on the base unit (shown at right).
2. Plug the AC adapter into a standard 120VAC wall outlet.
3. Check to see that the power LED is on.

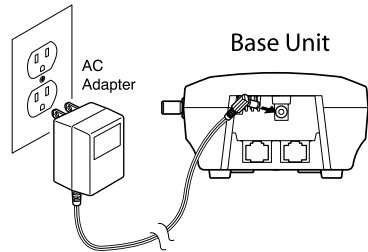

## Charging Unit

1. Plug the AC adapter cord into the input jack on the charging unit (shown at right).
2. Plug the AC adapter into a standard 120VAC wall outlet.
3. Check to see that the **CHARGE** LED is on.

**Note** You can place the handset in the charging unit with or without the belt clip attached.

### Important!

- *Use only the supplied AC adapter.*
- *If the **CHARGE** LED on the charging unit and/or the **POWER** LED on the base unit do not light, return everything to your Authorized Dealer.*
- *Always route the power cord where it is not a trip hazard, and where it cannot become chafed and create a fire or electrical hazard.*

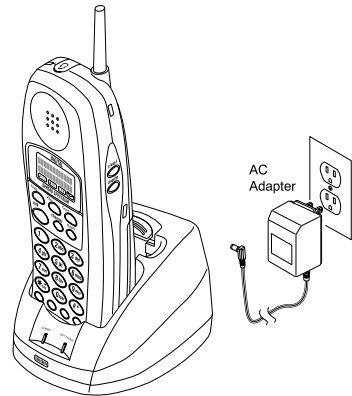

**DKT2204-CT (pictured)**

## Step 6: (Optional) Wall Installation

**Important!** *You must place your DKT3000-series telephone into 2000-mode before connecting the cordless telephone; otherwise, the 3000-series telephone will not work. See “Place DKT3000-series Telephones into 2000-Mode” on page 16 for instructions.*

### Standard Wall Plate Mounting

These telephones are designed to be mounted on a standard wall plate. To attach the wall mount stand to the base unit:

1. Select a wall location near a 120VAC outlet and within reach of the Strata CTX digital line connection.
2. Slide the wall mount stand into the notches at the top of the base unit, push the wall mount stand down and snap it into place (shown right).
3. Plug the AC adapter into the base unit.
4. Place the AC adapter cord inside the molded channel of the wall mount stand.
5. Plug one end of the telephone cord into the LINE jack on the base unit. Optionally, plug one end of a Strata DKT telephone into the PHONE jack. Then place the telephone cord(s) inside the molded channel(s) on the bottom of the wall mount stand.
6. Plug the other end of the telephone cord into the modular wall jack.
7. Place the base unit on the posts of the wall plate and push down until it's firmly seated (shown right).
8. Plug the AC adapter into a standard 120VAC wall outlet.

**Note** Do not use an outlet controlled by a wall switch.

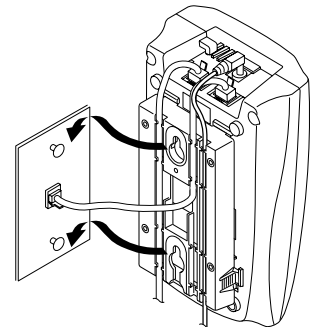
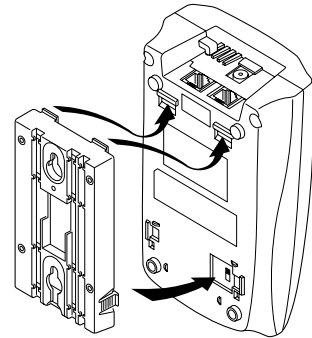

## Installation

### Step 6: (Optional) Wall Installation

## Direct Wall Mounting

If you do not have a standard wall plate, you can mount your telephone directly on a wall. Before mounting your telephone, consider the following:

- Select a location away from electrical cables, pipes, or other items behind the mounting location that could cause a hazard when inserting screws into the wall.
- Make sure the wall material is capable of supporting the weight of the base unit.
- Use #10 screws with anchoring devices suitable for the wall.

### ► To wall mount the base unit

1. Insert two mounting screws 3-15/16 inches apart. Allow about 3/16 of an inch between the wall and screw heads for mounting the telephone (shown right).
2. Plug and secure the AC adapter cord by following Steps 2 and 3 of the “[Standard Wall Plate Mounting](#)” on [page 19](#).
3. Plug one end of the telephone line cord into the LINE jack on the base unit. Optionally, plug one end of a Strata DKT telephone into the PHONE jack. Then place the telephone cord(s) inside the molded channel(s) on the bottom of the wall mount stand.
4. Place the base unit on the posts of the wall screws and push down until it's firmly seated.
5. Plug the other end of the telephone cord into a telephone wall jack.
6. Plug the AC adapter into a standard 120VAC wall outlet by following Step 7 of the [Standard Wall Plate Mounting](#).

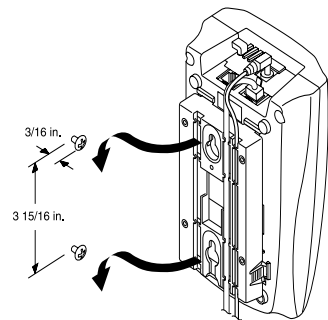
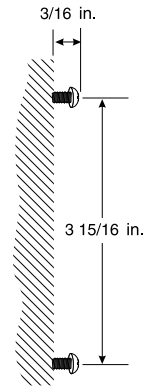

## Charging Unit Wall Mounting

The charging unit is also designed to be wall mounted. Before mounting your charging unit, consider the following:

- Select a location away from electrical cables, pipes, or other items behind the mounting location that could cause a hazard when inserting screws into the wall.
- Make sure the wall material is capable of supporting the weight of the charging unit.
- Use #10 screws with anchoring devices suitable for the wall material where the charging unit will be placed.

### DKT2204-CT

1. Insert two mounting screws 1-9/10 inches apart. Allow about 3/16 of an inch between the wall and screw heads for mounting the telephone.
2. Plug the AC adapter into the charging unit as previously described. Wrap the AC adapter cord around the strain relief (shown right).
3. Place the charging unit on the posts of the wall screws and push down until it's firmly seated (shown right).
4. Plug the AC adapter into a standard 120VAC wall outlet.

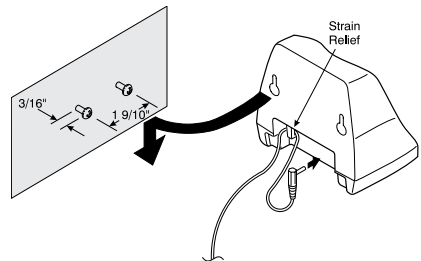
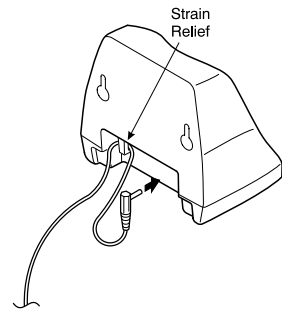

## Installation

### Step 6: (Optional) Wall Installation

#### DKT2304-CT

1. Insert two mounting screws 1-1/5 inches apart. Allow about 3/16 of an inch between the wall and screw heads for mounting the telephone (shown right).
2. Pass the one end through the hole of the wall mount stand and plug it into the charging unit. Wrap the AC adapter cord around the strain relief.
3. Slide the wall mount stand into the notches on the bottom of the charging unit.
4. Place the charging unit on the posts of the wall screws and push down until it's firmly seated (shown right).
5. Plug the AC adapter into a standard 120VAC wall outlet.

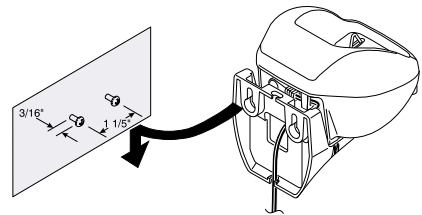
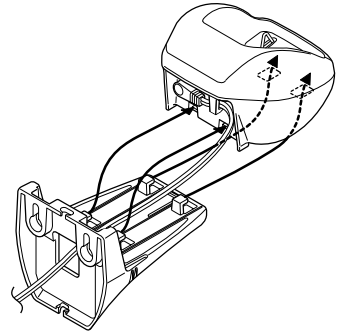



## Step 7: Raise the Base Unit Antenna

- Before using your handset, raise the base unit antenna to the vertical position.

## Step 8: Install Handset Battery Pack

### DKT2204-CT

1. Remove the battery cover by pressing the latch and sliding the cover down and off the handset.
2. Slide the battery pack down into the handset (shown right).
3. Securely close the battery compartment cover by sliding it up until it snaps into place.

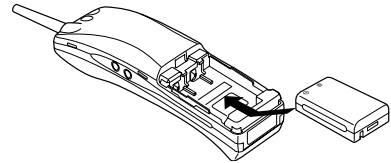

### DKT2304-CT

1. Remove the battery cover by pressing the latch and sliding the cover down and off the handset.
2. Connect the battery pack connector observing correct polarity to the jack inside the battery compartment. Do not exert any force on this connection. It could cause damage to the battery or handset. Once you are certain that you have made a good connection, then insert the battery pack into the battery compartment. Do not pinch the wires (shown right).
3. Securely close the battery compartment cover by sliding it up until it snaps into place.

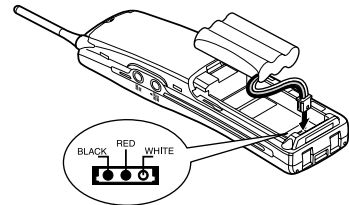

---

**CAUTION! Rechargeable Nickel-Metal-Hydrate batteries must be disposed of properly.**

---

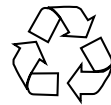

## Step 9: Charge Batteries for First Time

**Important!** *Before using your handset, the battery must be continuously charged for five hours.*

1. Place the handset in the charging unit (shown at right).
2. Ensure that the **CHARGE** LED lights. If it does not, make sure that the AC adapter is plugged in and that the handset is making good contact with the charging unit contacts.

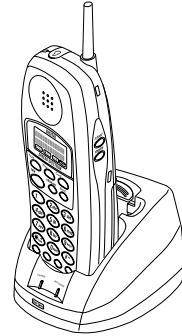

**DKT2204-CT Charging Unit (pictured)**

## Step 10: Install Headset (Optional)

The optional headset provides a hands-free option. With the headset installed, you can use the belt clip to carry the handset and conduct a conversation. All feature operations remain the same except the handset earphone and microphone are disconnected.

- Open the cover over the headset jack that is located on the top of the handset and plug in the headset as shown at right.

**Important!** *Only use headsets especially designed or modified for use with radio frequency equipment.*

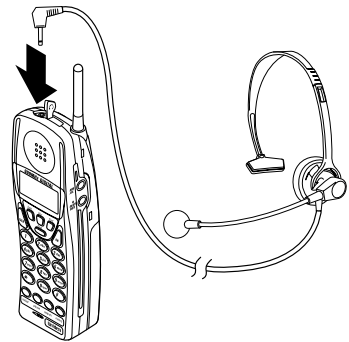

## Step 11: Attach Belt Clip (Optional)

**Note** The belt clip is designed to fit snugly onto the handset.

1. Snap the tab out of the belt clip notch on the top of the handset.
2. Slide the belt clip into the space where the belt clip tab was, carefully aligning the belt clip sides to the notches.
3. Press firmly until it snaps into place.
4. Use the belt clip to attach the handset to your belt or pocket.

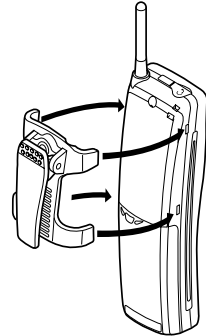

► **To remove the belt clip**

1. Press the retaining clip in toward the belt clip blade and slide the clip up at the same time.
2. Reinstall the cover tab.

## **Installation**

### *Step 9: Charge Batteries for First Time*

This chapter covers the handset volume control and various functions related to the handset itself.

## Handset Controls

### Earpiece Volume

- Press **R/VOL** (on DKT2204-CT) or **RING/VOL** (on DKT2304-CT) on the side of the handset during a call to select the earpiece volume of the handset (shown below). There are four levels—low, medium, high and maximum—from which to choose.

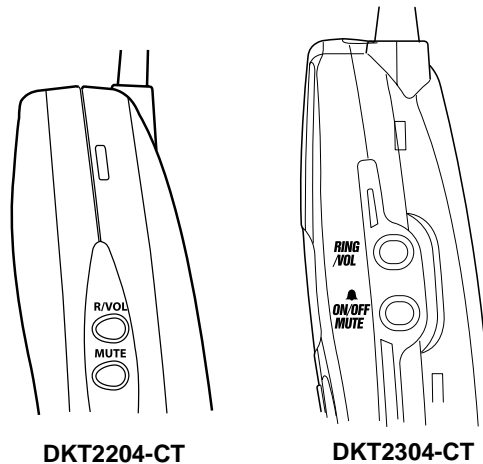

The LCD displays the volume level for two seconds.

## Handset Ringer Tone and Volume

- Press **R/VOL** (DKT2204-CT) or **RING/VOL** (DKT2304-CT) on the side of the handset in standby mode to select six ringer tones and volume combinations— Ring Type A, B and C. Each ring type has two levels, high and low.

## Mute (DKT2204-CT only)

- Press the **MUTE** button on the side of the handset to consult another person in the room without the caller hearing you. The **Talk** icon blinks.
- Press the **MUTE** button again to cancel the mute condition.

**Note** Finishing the conversation can also cancel mute condition.

## Handset Ringer Mute (DKT2304-CT only)

You can temporarily mute the handset ringer tone. In standby mode, press and hold **ON/OFF MUTE** on the side of the handset for two seconds. The Ring Off icon displays on the LCD. If you press and hold the key for two seconds again also in standby mode, the icon disappears.

## Vibrate Mode

- With the handset not on the charging unit:
  - (DKT2204-CT) Turn the Ringer Off Slide Switch to Off. The Ring Off icon displays on the LCD.
  - (DKT2304-CT) Press **RING/VOL** until the Ring Off icon  displays on the LCD.

The handset vibrates when there is an incoming call.

**Note** If you set the ringer Off with the handset on the charger, the handset rings as Ring Type-A Low.

## Ringer Off Slide Switch (DKT2204-CT only)

The switch on the side of the handset turns the handset ringer On or Off (shown right). When the switch on the side of the handset is turned to **off**, the Ring Off icon  displays on the LCD and incoming calls will no longer ring on the handset. When the switch on the side of the handset is turned to **on**, the Ring Off icon disappears and incoming calls ring on the handset.

**Note** Ringing is automatically turned on again if you press **Talk**, function or ringer/volume buttons, receive an incoming call, or if there is no user operation for five minutes in standby mode.

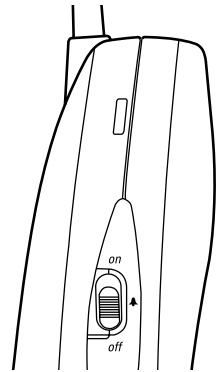

## F1~F4 Feature Buttons

The **F1~F4** buttons on your cordless telephone perform the same functions as the first four buttons on a Strata DKT3000/2000-series telephone. The **F1~F4** buttons were preassigned upon system installation. Ask your System Administrator which **F1~F4** button functions you have.

If you are not using these buttons for the assigned features, you can invoke the features with access codes. Please see [Table 3 on page 37](#) for access code sequences that match your Toshiba telephone system.

For detailed feature descriptions, see the *Strata CTX DKT/IPT Telephone User Guide*.

# Making a Call

**Note** If you are talking on a call and you have reached the range limit, move back in range within 35 seconds or the call is dropped.

## Internal Call

1. Pick up the handset and press **Talk**. The message “**ACQUIRING LINK**” displays on the LCD.

If the connection is made between the handset and base, you will see the current volume setting (shown right) for approx. two seconds. The **F1** LED turns on.

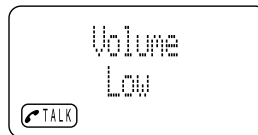

If the connection is not made or the handset is at the range limit of the DKT2204-CT/DKT2304-CT, the message “**NO SERVICE**” displays.

2. When you hear a dial tone, enter the number you are calling. The numbers display on the LCD.
3. When you finish the call, press the **Talk** button again, this hangs up the telephone and puts it in Auto Standby.

## External Call

1. Press **F2**. The handset starts to establish a connection with the base unit.

If the connection is made between the handset and base, you will see the current volume setting for approx. two seconds. The **F2** LED turns on.

2. When you hear a dial tone, enter the number you are calling. The numbers display on the LCD (shown right).
3. When you finish the call, press the **Talk** button again, this hangs up the telephone and puts it in Auto Standby.





# Answer a Call

## Internal Call

1. When you receive a call, the handset rings and the LCD displays “**STxx CALLING**” (where the calling party’s station number shows). The **F1** LED blinks.
2. Pick up the handset. The AutoTalk feature allows you to answer the call immediately.

**Note** If the handset is not in the charging unit, you must press **Talk**. The message “**ACQUIRING LINK**” displays on the LCD.

If the connection is made between the handset and base, you see the current volume setting for approx. two seconds. The **F1** LED turns on.

3. When you finish the call, place the handset back in the charging unit. AutoStandby automatically hangs up the telephone.

...or

press **Talk** to hang up the telephone.

## External Call

1. When you receive a call, the handset rings and the LCD displays “**LINE 1 RINGING**” The **F2** LED blinks.
2. Pick up the handset. The AutoTalk feature allows you to answer the call immediately.

**Note** If the handset is not in the charging unit, you must press **Talk**. The message “**ACQUIRING LINK**” displays on the LCD.

If the connection is made between the handset and base, you see the current volume setting for approx. two seconds. The **F2** LED turns on.

3. When you finish the call, place the handset back in the charging unit. AutoStandby automatically hangs up the telephone.

...or

press **Talk** to hang up the telephone.

## Place a Call on Hold

- Press **Hold**.
- **To resume the call**
  - Press **Hold** or **Talk**.

## Transfer a Call

- Press **Cnf/Trn**. The dialed numbers saved in transfer memory is shown on the display after two seconds. When the receiving party answers, press **Cnf/Trn** to complete the transfer.

## Redial a Number

- Press **Talk** and then **Redial**. The last number called is redialed.

**Note** If you are using the Strata CTX system, the **Redial** button works only with the last dialed number that was answered. If you dial a number and receive no answer, the **Redial** button will not use that number as the last one dialed.

## Retrieve Messages

- Press **Msg** when you see the envelope icon on the LCD to retrieve your message(s).



## Conference a Call

- Press **Cnf/Trn**. The dialed numbers saved in conference memory is shown on the display after two seconds. When the other party answers, press **Cnf/Trn** to have a three-way conversation.

# Conference Calls Using Strata CTX

You can conference together up to eight parties (including your own) - with up to six parties being external CO or network lines. The actual number of conference parties with acceptable volume levels depends on the local and far end telephone line conditions.

The person who initiates the conference call is the Master. If, after the conference is established and the Master exits the conference, the first station to have been added to the conference becomes the Master. If no other internal stations are included in the conference call, the call is disconnected.

## ► To conference calls

1. While on a call, press **Cnf/Trn**. You hear dial tone.
2. Call another station or outside line.
3. When the called party answers, press **Cnf/Trn**. If you receive a busy tone or no answer, press **Cnf/Trn** again to return to the original connection. All parties are conferenced.
4. Repeat the above steps to add lines to the conference. Keep in mind the maximum number of allowed conference parties.

## ► To transfer conference control

1. Do Steps 1 and 2 above to add the line to which you wish to transfer conference control.
2. Announce the call and hang up to transfer the call. This station now becomes the conference “master” with the ability to add or delete parties.

## ► To hold a conference call

- If you are the Conference Master, press the **Hold** key once (or twice for Executive Hold) to place the conference call on hold. The other parties can continue with the conference. Music-on-hold is suppressed.
- Press **Cnf/Trn** to rejoin the conference at any time. When you return, you retain Master status.

## Adding Voice Mail to a Conference

The Conference Master can add voice mail to a conference. This enables participants in a conference to listen to or leave a voice mail message during a telephone call.

► **To add Voice Mail to a conference call (performed by Conference Master)**

1. Press **Cnf/Trn** to place the current call on Consultation Hold.
2. Dial the voice mail (VM) extension number, then enter the VM mailbox and security code. This adds the voice mailbox to the conference.
3. Press **Cnf/Trn** to reconnect to the original party. (You can continue to add conference members by pressing **Cnf/Trn** and dialing another extension.)

Now, all parties in the conference can listen to or record a message to this voice mailbox. Only the Master can control the VM with touchtones or Soft Keys.

## Connecting Two Outside Lines

1. While talking on an outside call, press **Cnf/Trn**. You hear dial tone.
2. Dial an outside line access code and outside telephone number.
3. After the party answers, press **Cnf/Trn**. All parties are conferenced.  
If you receive a busy tone or if the station does not answer, press **Cnf/Trn**.
4. Hang up. The two lines are connected.
5. To supervise a tandem call, press **Cnf/Trn**. If the parties have finished, hang up or if the parties are still talking, press **Cnf/Trn** and hang-up. Both Line LEDs turn off and the connection is released.

If your telephone company provides auto disconnect, the connection may release automatically when the parties hang up. If not, the lines must be supervised to be disconnected.

## Switch a Call to Your Cordless Digital Telephone

1. Press **Hold** on the desktop telephone and press **Talk** on the DKT2204-CT/DKT2304-CT handset.
2. Pick up the cordless telephone and press the flashing Line LED. The call is now transferred to the DKT2204-CT/DKT2304-CT handset, and the DKT telephone is disconnected.

## Switch a Call to the Desk Telephone

1. Press **Hold** on the DKT2204-CT/DKT2304-CT handset.
2. Pick up the DKT telephone and press the flashing Line LED. The cordless telephone is disconnected.

## **Handset Operation**

*Switch a Call to the Desk Telephone*

# Feature Access Codes

# 4

This chapter gives you all of the cordless digital telephone features in alphabetical order. Your cordless digital telephone provides many of the same features as a 2000-series corded digital telephone.

In addition to the **Msg**, **Hold**, **Cnf/Trn** and **Redial** functions, your cordless digital telephone's **F1~F4** buttons perform the same way as the first four buttons on your 3000- or 2000-series digital telephone. They are assigned during system installation. See your System Administrator for the features that have been assigned.

If you are not using these buttons for the assigned features, you can invoke the features with access codes. Please see [Table 3](#) below for access code sequences that match your Toshiba telephone system.

For detailed feature descriptions, see the *Strata CTX DKT/IPT Telephone User Guide*.

**Table 3 Feature Access Codes**

Feature	Feature Access Code Sequences
Account Code	<b>Cnf/Trn + #46</b> + Account code digits
Attendant Console	<b>0</b>
Automatic Busy Redial - On	<b>#441</b>
Automatic Busy Redial - Off	<b>#442</b>
Automatic Callback Cancel	<b>#431</b>
Background Music	
Telephone Speaker On	Ext. button + <b>#490</b> + source number + #
Telephone Speaker Off	Ext. button + <b>#491</b>
External Speaker On	Ext. button + <b>#492</b> + source number + #

## Feature Access Codes

Switch a Call to the Desk Telephone

**Table 3 Feature Access Codes** (continued)

Feature	Feature Access Code Sequences
External Speaker Off	Ext. button + <b>#493</b>
<b>Call Forward - See Table 4 on page 41.</b>	
<b>Call Park</b>	
Activate	<b>Cnf/Trn + #33</b> + Orbit Number
Retrieve	Ext. button + <b>#32</b> + Orbit Number
System Orbits	<b>7000~7019</b>
<b>Call Pickup</b>	
Incoming - Group Pickup	Ext. button + <b>#5#34</b>
Incoming - Directed Extension Pickup	Ext. button + <b>#5#5</b> + Ext. Number to be picked up
Incoming - Directed Group Pickup	Ext. button + <b>#5#32</b> + Group Number to be picked up
Incoming - Directed Extension Pickup	Ext. button + <b>#5#22</b> + Ext. Number
Directed DN Pickup of either Ringing or Held Call	Ext. button + <b>#5#6</b> + Ext. Number
On hold - Local Retrieve	Ext. button + <b>#5#71</b>
On hold - Remote Retrieve	Ext. button + <b>#5#72</b> + Remote Ext. No.
On hold - Outside line Retrieve	Ext. button + <b>#5#73</b> + Line on hold
On hold - Directed Extension Retrieve	Ext. button + <b>#5#74</b> + Ext. No. on hold
<b>Conferencing - Three Way</b>	<b>#494</b>
<b>Dialing</b>	
Dial *	<b>441</b>
Dial #	<b>440</b>
<b>DISA Security Code - Change</b>	<b>#658</b> + old Security Code (1~15 digits) + # + new Security Code (1~15 digits) + #
<b>Do Not Disturb</b>	
Local - On	<b>#6091</b>
Local - Off	<b>#6092</b>
Remote - On	<b>#6191</b> + ext. no. + Pass Code Number + #
Remote - Off	<b>#6192</b> + ext. no. + Pass Code Number + #



**Table 3 Feature Access Codes** (continued)

Feature	Feature Access Code Sequences
Door Lock Control	#12 + Door Lock Number
Door Phone Calling	#15 + Door Phone No. (01~24, depending on system size)
Emergency Call	#911
Flash - Short	#450
Flash - Long	#451
LCD Language (Change)	#495 + Language No.
LCR (Outgoing Call)	9
<b>Message Waiting (MW)</b>	
Release a received MW	#409
Retrieve a received MW	#408
Activate MW at another Station without Ringing	#63 + Ext. no.
Cancel MW at another Station without Ringing	#64 + Ext. no.
<b>Messaging - Advisory</b>	
Advisory Message - Activation	#411 + Message No.
Advisory Message - Cancellation	#412
<b>Network Access Code (Private Network)</b>	8 + Private Network No.
<b>Night Ring Answer</b>	#5#39
<b>Off-hook Call Announce (Manual Mode)</b>	Voice First: 2; Tone First: 1, 21, or 12
<b>Override</b>	
Busy, Do Not Disturb	2
Executive	3
<b>Paging</b>	
Page All Groups	#30
Page Individual Groups	#31 + Group Number
Emergency Page - Individual Group	#38 + Group Number

## Feature Access Codes

Switch a Call to the Desk Telephone

**Table 3 Feature Access Codes** (continued)

Feature	Feature Access Code Sequences
Emergency Page - All Groups	<b>#37</b>
Answer for External Group Page	<b>#5#36</b> + Zone Number
<b>Repeat Last Number Dialed</b>	<b>* 0</b>
<b>Speed Dial Register</b>	<b>#66</b>
Station (00~99)	<b>* 1</b> + Index Number (00~99)
System	<b>* 2</b> + Index Number (000~099)
	<b>* 3</b> + Index Number (100~199)
	<b>* 4</b> + Index Number (200~299)
	<b>* 5</b> + Index Number (300~399)
	<b>* 6</b> + Index Number (400~499)
	<b>* 7</b> + Index Number (500~599)
	<b>* 8</b> + Index Number (600~699)
	<b>* 9</b> + Index Number (700~799)
<b>Start Application</b>	<b>#18</b>
<b>Substitution of Dial “#”</b>	<b>440</b>
<b>Substitution of Dial “*”</b>	<b>441</b>
<b>Travelling Class Override</b>	
Enter Code	<b>#471</b>
Change Code	<b>#69</b> + Index Number + old Code + # + new Code + #
<b>User Programming Mode</b>	<b>#9876</b>
<b>Voice Mail (VM)</b>	
Direct Transfer to Voice Mail	<b>#407</b> + Ext. Number
<b>Volume Control - Beep</b>	<b>#6101</b>
<b>Volume Control - Ringing</b>	<b>#6102</b>

**Table 4 Call Forward Procedure**

Feature	Button Sequence
<b>Call Forward Any Call - Internal and Incoming Line Calls:</b>	
Forwards any call, whether an internal call or incoming line call.	
All Calls to an ext.	Press ext. button + <b>#6011</b> (tone) + dial the dest. ext. no. (tone)
All Calls to outside telephone no.	Press ext. button + <b>#6011</b> (tone) + outside line access code + dest. telephone no. + # (tone)
Busy to an ext.	Press ext. button + <b>#6021</b> (tone) + dial the dest. ext. no. (tone)
Busy to outside telephone no.	Press ext. button + <b>#6021</b> (tone) + outside line access code + dest. telephone no. + # (tone)
No Answer to an ext.	Press ext. button + <b>#6031</b> (tone) + dial the dest. ext. no. + timer ( <b>08~60</b> ) (tone)
No Answer to outside telephone no.	Press ext. button + <b>#6031</b> (tone) + outside line access code + dest. telephone no. + # (tone) + timer ( <b>08~60</b> ) (tone)
Busy No Answer to an ext.	Press ext. button + <b>#6041</b> + dial the dest. ext. no. (tone) + timer ( <b>08~60</b> ) (tone)
Busy No Answer to outside telephone no.	Press ext. button + <b>#6041</b> + outside line access code + dest. telephone no. + # + timer ( <b>08~60</b> ) (tone)
Cancel	Press ext. button + <b>#6051</b> (tone)
<b>Call Forward - Incoming Line Calls:</b>	
Forward incoming line calls only.	
All Calls to an ext.	Press ext. button + <b>#6013</b> (tone) + dial the dest. ext. no. (tone)
All Calls to outside telephone no.	Press ext. button + <b>#6013</b> (tone) + outside line access code + dest. telephone no. + # (tone)
Busy to an ext.	Press ext. button + <b>#6023</b> (tone) + dial the dest. ext. no. (tone)
Busy to outside telephone no.	Press ext. button + <b>#6023</b> (tone) + outside line access code + dest. telephone no. + # (tone)
No Answer to an ext.	Press ext. button + <b>#6033</b> + dial the dest. ext. no. (tone) + timer ( <b>08~60</b> )
No Answer to outside telephone no.	Press ext. button + <b>#6033</b> + outside line access code + dest. telephone no. + # (tone) + timer ( <b>08~60</b> )
Busy No Answer to an ext.	Press ext. button + <b>#6043</b> + dial the dest. ext. no. (tone) + timer ( <b>08~60</b> ) (tone)

## Feature Access Codes

### Switch a Call to the Desk Telephone

**Table 4 Call Forward Procedure** (continued)

Feature	Button Sequence
Busy No Answer to outside telephone no.	Press ext. button + <b>#6043</b> + outside line access code + dest. telephone no. + <b>#</b> (tone) + timer ( <b>08~60</b> ) (tone)
Cancel	Press ext. button + <b>#6053</b> (tone)
<b>Call Forward Any Call - Set for Another Station:</b> Enables you to set call forwarding for another telephone within your telephone system. You will need the other telephone's CF pass code in order to do this. CF Pass Codes are created in system programming.	
All Calls to an ext.	Press ext. button + <b>#6012</b> (tone) + dial the other telephone's ext. no. + enter other telephone's CF pass code + <b>#</b> + dest. telephone no. (tone)
All Calls to outside telephone no.	Press ext. button + <b>#6012</b> (tone) + dial the other telephone's ext. no. + enter other telephone's CF pass code + <b>#</b> + outside line access code + dest. telephone no. + <b>#</b> (tone)
Busy to an ext.	Press ext. button + <b>#6022</b> (tone) + dial the other telephone's ext. no. + enter other telephone's CF pass code + <b>#</b> + dest. telephone no. (tone)
Busy to outside telephone no.	Press ext. button + <b>#6022</b> (tone) + dial the other telephone's ext. no. + enter other telephone's CF pass code + <b>#</b> + outside line access code + dest. telephone no. + <b>#</b> (tone)
No Answer to an ext.	Press ext. button + <b>#6032</b> (tone) + dial the other telephone's ext. no. + enter other telephone's CF pass code (tone) + <b>#</b> + dest. telephone no. (tone) + timer ( <b>08~60</b> ) (tone)
No Answer to outside telephone no.	Press ext. button + <b>#6032</b> (tone) + dial the other telephone's ext. no. + enter other telephone's CF pass code (tone) + <b>#</b> + outside line access code + dest. telephone no. + <b>#</b> (tone) + timer ( <b>08~60</b> ) (tone)
Busy No Answer to an ext.	Press ext. button + <b>#6042</b> + dial the other telephone's ext. no. + enter other telephone's CF pass code + <b>#</b> (tone) + dest. telephone no. (tone) + timer ( <b>08~60</b> ) (tone)
Busy No Answer to outside telephone no.	Press ext. button + <b>#6042</b> + dial the other telephone's ext. no. + enter other telephone's CF pass code + <b>#</b> (tone) + outside line access code + dest. telephone no. + <b>#</b> (tone) + timer ( <b>08~60</b> ) (tone)
Cancel	Press ext. button + <b>#6052</b> (tone) + dial the other telephone's ext. no. + enter other telephone's CF pass code + <b>#</b> (tone)

**Table 4 Call Forward Procedure** (continued)

Feature	Button Sequence
<p><b>Call Forward - Incoming Line Call - Set for Another Station:</b> Enables you to set forwarding of incoming line calls for another telephone within your telephone system</p>	
All Calls to an ext.	Press ext. button + <b>#6014</b> (tone) + dial the other telephone's ext. no. + enter other telephone's CF pass code + # (tone) + dest. telephone no. (tone)
All Calls to outside telephone no.	Press ext. button + <b>#6014</b> (tone) + dial the other telephone's ext. no. + enter other telephone's CF pass code + # (tone) + outside line access code + dest. telephone no. + # (tone)
Busy to an ext.	Press ext. button + <b>#6024</b> (tone) + dial the other telephone's ext. no. + enter other telephone's CF pass code + # (tone) + dest. telephone no. (tone)
Busy to outside telephone no.	Press ext. button + <b>#6024</b> (tone) + dial the other telephone's ext. no. + enter other telephone's CF pass code + # (tone) + outside line access code + dest. telephone no. + # (tone)
No Answer to an ext.	Press ext. button + <b>#6034</b> (tone) + dial the other telephone's ext. no. + enter other telephone's CF pass code + # (tone) + dest. telephone no. (tone) + timer <b>(08~60)</b>
No Answer to outside telephone no.	Press ext. button + <b>#6034</b> (tone) + dial the other telephone's ext. no. + enter other telephone's CF pass code + # (tone) + outside line access code + dest. telephone no. + # (tone) + timer <b>(08~60)</b> (tone)
Busy No Answer to an ext.	Press ext. button + <b>#6044</b> (tone) + dial the other telephone's ext. no. + enter other telephone's CF pass code + # (tone) + dest. telephone no. (tone) + timer <b>(08~60)</b> (tone)
Busy No Answer to outside telephone no.	Press ext. button + <b>#6044</b> (tone) + dial the other telephone's ext. no. + enter other telephone's CF pass code + # (tone) + outside line access code + dest. telephone no. + # (tone) + timer <b>(08~60)</b> (tone)
Cancel	Press ext. button + <b>#6054</b> (tone) + dial the other telephone's ext. no. + enter other telephone's CF pass code + # (tone)
<p><b>Change Call Forward Pass Code:</b> Your telephone must be enabled in programming to have the ability to change pass codes.</p>	
Change Pass Code	Press ext. button + <b>#670</b> (tone) + dial the dest. ext. no. (tone) + old pass code + # (tone) + new pass code (tone) + #

## **Feature Access Codes**

*Switch a Call to the Desk Telephone*

# Troubleshooting and Specifications

---

# 5

This chapter covers these topics:

- Troubleshooting
- Simultaneous conversation channels
- Range and performance
- Radio interference
- Telephone line problems
- More than one cordless telephone
- Privacy
- Specifications

## Troubleshooting

If your cordless telephone is not performing to your expectations, try the suggestions in [Table 5](#). If you are still unable to resolve the problem, contact your telephone System Administrator.

**Important!** *Do not attempt to service this unit yourself. All service must be done by qualified service personnel.*

**Table 5 Troubleshooting Suggestions**

<b>Condition</b>	<b>Suggestion</b>
CHARGE LED does not light when handset is placed on charging unit.	<ul style="list-style-type: none"><li>• Make sure the AC adapter is plugged into the charging unit and wall outlet.</li><li>• Make sure handset is properly seated in charging unit.</li><li>• Make sure the battery pack is properly placed in the handset.</li><li>• Make sure that the charging contacts on the handset and charging unit are clean.</li></ul>
Conversation is interrupted frequently.	<ul style="list-style-type: none"><li>• Make sure that the base unit antenna is fully vertical.</li><li>• Move closer to the base unit.</li><li>• Check for low battery warning.</li></ul>
Warning tone and NO SERVICE message.	<ul style="list-style-type: none"><li>• Move closer to the base unit.</li><li>• Make sure the AC adapter is plugged into the base unit and wall outlet.</li></ul>
Handset doesn't ring.	<ul style="list-style-type: none"><li>• The battery pack may be weak. Charge the battery pack for five~six hours.</li><li>• Make sure the base unit antenna is fully vertical.</li><li>• The handset may be too far away from the base unit.</li><li>• The ringer may be set to Off.</li><li>• Make sure the AC adapter is plugged into the base unit and wall outlet.</li></ul>



## Low Battery

Your cordless telephone comes equipped with one rechargeable battery:

- DKT2204-CT: BT2499 battery that provides six hours of talk and four days of standby time (fully charged).
- DKT2304-CT: BT930 battery that provides seven hours of talk and five days of standby time (fully charged).

A “fast charge” in the handset and a “trickle charge” in the charging unit enables the extended talk and standby times.

When the battery is low, the Battery icon displays on the LCD (shown right) and the handset beeps. Low battery symptoms are:



- On a call
  - All buttons and functions operate
  - Handset beeps once every three seconds

**Note** To continue your call, you must replace the battery pack within 20 seconds.

- In standby mode
  - None of the buttons operate
  - LCD messages are cleared
  - Handset beeps every 15 seconds for three minutes
  - Cannot make or receive call

To restore your battery capacity, return the handset to the charging unit for charging or replace the handset battery with a charged one. If the handset is on the charging unit for one minute, battery low condition is cancelled. The Battery icon is turned Off and battery low tone stops.

For more information on installing and charging the battery, see [Step 8: “Install Handset Battery Pack”](#) on [page 23](#).

## Cleaning Charging Unit Contacts

To maintain a good charge, it is important to clean all charging contacts on the handset, spare battery pack (DKT2204-CT only) and charging unit about once a month (shown right). Use a pencil eraser or a soft dry cloth. Do not use any liquids or solvents.

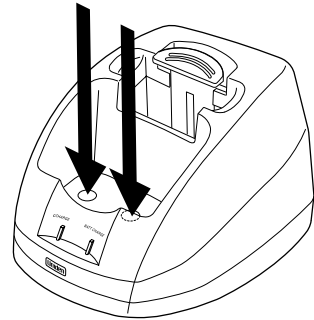

DKT2204-CT Charging Unit (pictured)

## Charging Spare Battery Packs (DKT2204-CT only)

The charging unit of your cordless telephone is equipped to charge the spare battery pack with or without the handset in the front slot.

1. Slide the spare battery pack into the second slot in the charging unit until the retaining clip snaps over the top of the pack.
2. Make sure the **BATT CHARGE** indicator lights. If the **BATT CHARGE** indicator doesn't light, check to see that the AC adapter is plugged in, and that the battery pack is making good contact with the unit's charging contacts.

**Note** Charge the battery pack without interruption for 12~15 hours.

3. When charging is complete, press out on the latch and remove the battery pack for use. Or, if you don't need the battery pack immediately, leave it in the charging compartment. It will not overcharge.

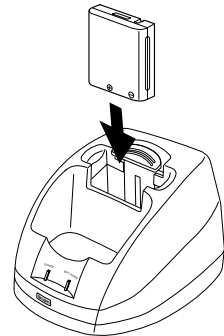

# Simultaneous Conversation Channels

## DKT2204-CT

The DKT2204-CT cordless digital telephone has 10 operating channels available.

A common misconception is that this limits a customer to 10 cordless telephones. This is not the case. Each cordless digital telephone can operate on any of the 10 channels. When you turn on a cordless digital telephone, the telephone selects an available channel within its' range. In a given cordless range, 10 simultaneous calls can be made. In most businesses, it is unlikely that all 10 channels will be in use at the same time. Typically 20 to 30 telephones can share the 10 channels.

Another factor is the distribution of the telephones in a facility. If your cordless digital telephones are disbursed throughout a facility, there should not be contention for channels. If there are more than 10 cordless digital telephones in one area and 10 users are using their cordless telephones, an 11<sup>th</sup> user would not be able to connect at that time.

## DKT2304-CT

The DKT2304-CT cordless handset has 30 operating channels available. A common misconception is that this limits a customer to 30 handsets. This is not the case. Each handset can operate on any of the 30 channels because each one selects an available channel within its range. In a given range, 30 simultaneous calls can be made.

Another factor is the distribution of the telephones in a facility. If your handsets are disbursed throughout a facility, there should not be contention for all channels. If there are more than 30 in one area and 30 users are using their handsets, the 31<sup>st</sup> user would not be able to get dial tone.

## Range and Performance

The DKT2204-CT operates up to 1.1 miles and the DKT2304-CT .7 miles from its base in a completely unrestricted test environment. Typically, ranges of 300 to 400 feet are possible, depending on the building structure in which it is used. For optimum range and performance from your handset, try the following:

- Place the base units at least three to six feet away from the DKT; three feet from metal structures; and six feet from computers, fax machines or other electronic equipment.
- Use an AC outlet not associated with computer or electromagnetic equipment.
- Wherever possible, put the base unit in the middle of the coverage area.
- Mount the base unit high in the room for maximum range.
- If you have two to three cordless telephones, put them 12 feet apart.
- If you have four to 10 cordless telephones, put them 20 feet apart.
- If you want to use more than one cordless telephone in your office, they must operate on different channels. Press the **Channel** (DKT2204-CT)/**CH** (DKT2304-CT) button on the handset to select a channel that provides the clearest communication.

## Radio Interference

Radio interference occasionally interrupts conversations, which does not mean that your unit is defective. Move to a different location while you are talking. If the interference continues, move the base unit. If there is still interference, contact your System Administrator.

## Telephone Line Problems

The FCC and IC have granted the telephone company the right to disconnect service in the event that your telephone causes problems on the telephone line. Also, the telephone company may make changes in facilities and services which may affect the operation of your unit. However, your telephone company must give adequate notice in writing prior to such actions to allow you time for making necessary arrangements to continue uninterrupted service.

If you are having trouble with your telephone service, you must first disconnect your telephone to determine if it is the cause of your problem. If you determine that it is the cause, you must leave it disconnected until the trouble has been corrected.

## Privacy

Cordless telephones are radio devices. Communications between the handset and base unit of your cordless telephone are accomplished by means of radio waves which are broadcast over the open airways. Because of the inherent physical properties of radio waves, your communications can be received by radio receiving devices other than your own cordless telephone unit. Consequently, any communications using your cordless telephone may not be private.

# Specifications

For frequencies, power requirements, weight and size specifications, see [Table 6](#).

**Table 6 Specifications**

Feature	DKT2204-CT	DKT2304-CT
<b>General</b>		
Frequency Control	Phase Lock Loop	
Modulation	Spread Spectrum	Digital
Operating Temperature	0° to 50° C (+32° F to + 122°F)	
<b>Base Unit</b>		
Receive/Transmit Frequency	902~928 MHz	
Power Requirements	10VDC from supplied AC adapter	
Size	Width – 4.25 inches Depth – 7.5 inches Height – 2.25 inches	Width – 4.25 inches Depth – 7 5/8 inches Height – 2.25 inches
Weight	Approximately 15.4 oz.	Approximately 13.7 oz.
<b>Handset</b>		
Receive/Transmit Frequency	902~928 MHz	905~925 MHz (30 channels)
Power Requirements	Nickel-cadmium battery pack	Ni-MH Battery Pack
Size	Width – 2 1/5. inches Depth – 1 2/3 inches Height – 8 2/3 inches with antenna	Width – 2. inches Depth – 1.25 inches Height – 5.5 inches without antenna
Weight	Approximately 8.8 oz. with battery	Approximately 5.2 oz. with battery
Battery	Capacity – 800 mAh, 3.6V Talk Mode – 6 hours (typical) Standby Mode – 4 days (typical)	Capacity – 800 mAh, 3.6V Talk Mode – 7 hours (typical) Standby Mode – 5 days (typical)

# Index

---

## A

- AC adapter, 18
- access codes, 37
- account codes, 37
- advisory messaging, 39
- answering calls, 31
- applications, 3
- attach belt clip, 25
- attendant console, 37
- automatic
  - busy redial, 37
  - callback cancel, 37

## B

- background music (BGM), 37
- base unit, 9, 18
  - antenna, 23
- battery, 10, 15
  - charging, 24
  - charging spare packs, 48
  - install in handset, 23
  - low, 47
  - removing and charging, 24
  - warnings, 15
- belt clip, 25
- benefits, 3
- buttons

- F1~F4 feature, 29
- fixed, 6, 8

## C

- call
  - hold, 32
  - park, 38
  - pickup, 38
- charging unit, 10, 18
  - cleaning contacts, 48
- conference, 6, 8
  - calls, 32, 33, 38
  - Strata CTX calls, 33
  - voice mail, 34
- connect and apply power, 18
- connect telephone cables, 17

## D

- digital technology, 2
- DISA
  - security code, 38
- do not disturb, 38
- door lock
  - control, 39
- door phone
  - calling, 39

**E**

emergency call, 39

**F**

feature access codes, 29, 37

features, 2

fixed buttons, 6, 8

flash, 39

**H**

handset, 4, 27

controls, 27

mute button, 28

ringer mute, 28

ringer off slide switch, 29

ringer tone and volume, 28

vibrate mode, 28

volume, 27

hold, 6, 8

**I**

installation instructions, 13

installing optional headset, 24

**L**

language changes, 39

LCD display, 9

LCR dialing out, 39

**M**

making calls, 30

memory, 29

message

retrieve, 32

waiting, 39

message waiting, 3, 9

messaging

advisory, 39

mute, 6, 8, 28

**N**

narrow band technology, 2

network access, 39

night ring answer, 39

**O**

off-hook call announce (OCA), 39

on hold calls, 32

override

access codes, 39

travelling class, 40

**P**

paging

access codes, 39

park, 38

performance, 50

privacy, 51

private network access, 39

**R**

radio interference, 50

range, 50

redial, 6, 8, 32, 40

retrieve messages, 32

**S**

safety instructions, 13

select location, 16

simultaneous conversation channels, 49

specifications, 52

speed dial

access codes, 40

spread spectrum technology, 2



standard parts, 11  
start application, 40  
switching calls between desk/cordless, 35

## T

telephone line problems, 50  
transfer calls, 6, 8, 32  
travelling class override, 40  
troubleshooting, 45  
two (tandem) CO line connection, 34

## U

user programming, 40

## V

voice mail  
    access codes, 40  
    conference, 34  
volume control, 40

## W

wall installation  
    charging unit wall mounting, 21  
    direct wall mounting, 20  
    standard wall plate mounting, 19